

TOSHIBA FIELD EFFECT TRANSISTOR SILICON N CHANNEL DUAL GATE MOS TYPE

# 3SK153

TV TUNER, UHF RF AMPLIFIER APPLICATIONS  
TV TUNER VHF WIDE BAND RF AMPLIFIER APPLICATIONS

Unit in mm

- Superior Cross Modulation Performance.
- Low Reverse Transfer Capacitance :  $C_{RSS} = 0.025\text{pF}$  (Typ.)
- Low Noise Figure :  $NF = 2.6\text{dB}$  (Typ.)

MAXIMUM RATINGS ( $T_a = 25^\circ\text{C}$ )

CHARACTERISTIC	SYMBOL	RATING	UNIT
Drain-Source Voltage	$V_{DS}$	13.5	V
Gate 1-Source Voltage	$V_{G1S}$	$\pm 8$	V
Gate 2-Source Voltage	$V_{G2S}$	$\pm 8$	V
Drain Current	$I_D$	30	mA
Drain Power Dissipation	$P_D$	150	mW
Channel Temperature	$T_{ch}$	125	$^\circ\text{C}$
Storage Temperature Range	$T_{stg}$	$-55 \sim 125$	$^\circ\text{C}$

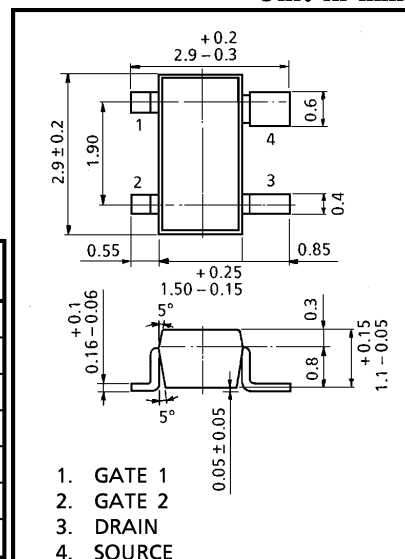

1. GATE 1
2. GATE 2
3. DRAIN
4. SOURCE

SMQ	
JEDEC	—
EIAJ	—
TOSHIBA	2-3J1A

Weight : 0.013g

Marking

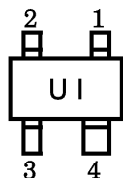

ELECTRICAL CHARACTERISTICS ( $T_a = 25^\circ\text{C}$ )

CHARACTERISTIC	SYMBOL	TEST CONDITION	MIN.	TYP.	MAX.	UNIT
Gate 1 Leakage Current	$I_{G1SS}$	$V_{DS} = 0, V_{G1S} = \pm 6\text{V}, V_{G2S} = 0$	—	—	$\pm 50$	nA
Gate 2 Leakage Current	$I_{G2SS}$	$V_{DS} = 0, V_{G1S} = 0, V_{G2S} = \pm 6\text{V}$	—	—	$\pm 50$	nA
Drain-Source Voltage	$V$ (BR) DSX	$V_{G1S} = -4\text{V}, V_{G2S} = -4\text{V}, I_D = 100\mu\text{A}$	13.5	—	—	V
Drain Current	$I_{DSS}$ (Note)	$V_{DS} = 6\text{V}, V_{G1S} = 0, V_{G2S} = 3\text{V}$	0	—	2	mA
Gate 1-Source Cut-off Voltage	$V_{G1S}$ (OFF)	$V_{DS} = 6\text{V}, V_{G2S} = 3\text{V}, I_D = 100\mu\text{A}$	-1.5	—	1	V
Gate 2-Source Cut-off Voltage	$V_{G2S}$ (OFF)	$V_{DS} = 6\text{V}, V_{G1S} = 3\text{V}, I_D = 100\mu\text{A}$	-1.0	—	1	V
Forward Transfer Admittance	$ Y_{fs} $	$V_{DS} = 6\text{V}, V_{G2S} = 3\text{V}, I_D = 10\text{mA}, f = 1\text{kHz}$	—	21	—	mS
Input Capacitance	$C_{iss}$	$V_{DS} = 6\text{V}, V_{G2S} = 3\text{V}, I_D = 10\text{mA}, f = 1\text{MHz}$	1.8	2.7	3.6	pF
Reverse Transfer Capacitance	$C_{rss}$		—	0.025	0.05	pF
Power Gain	$G_{ps}$	$V_{DS} = 6\text{V}, V_{G2S} = 3\text{V}, I_D = 10\text{mA}, f = 800\text{MHz}$ (Fig.1)	14	18.5	—	dB
Noise Figure	NF		—	2.6	4.0	dB

Note :  $I_{DSS}$  Classification 0 : 0~2mA

961001EAA2

- TOSHIBA is continually working to improve the quality and the reliability of its products. Nevertheless, semiconductor devices in general can malfunction or fail due to their inherent electrical sensitivity and vulnerability to physical stress. It is the responsibility of the buyer, when utilizing TOSHIBA products, to observe standards of safety, and to avoid situations in which a malfunction or failure of a TOSHIBA product could cause loss of human life, bodily injury or damage to property. In developing your designs, please ensure that TOSHIBA products are used within specified operating ranges as set forth in the most recent products specifications. Also, please keep in mind the precautions and conditions set forth in the TOSHIBA Semiconductor Reliability Handbook.
- The information contained herein is presented only as a guide for the applications of our products. No responsibility is assumed by TOSHIBA CORPORATION for any infringements of intellectual property or other rights of the third parties which may result from its use. No license is granted by implication or otherwise under any intellectual property or other rights of TOSHIBA CORPORATION or others.
- The information contained herein is subject to change without notice.

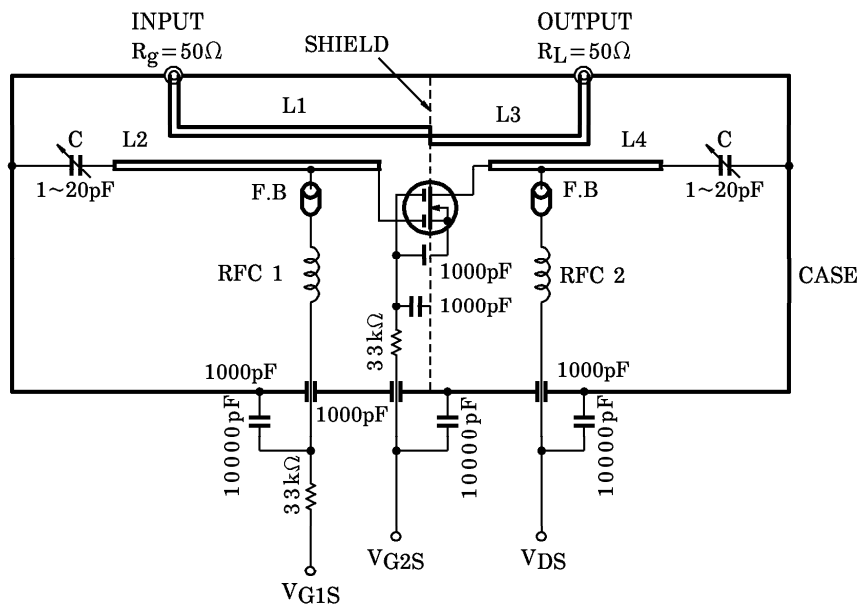

L1~L4 :  $\phi$ 0.8mm SILVER PLATED COPPER WIRE  
 C : AIR TRIMMER TTA25A200A (MURATA MFG. Co., LTD. )  
 RFC 1 :  $\phi$ 0.35mm COPPER WIRE 3mm ID, 7T  
 RFC 2 :  $\phi$ 0.35mm COPPER WIRE 3mm ID, 10T

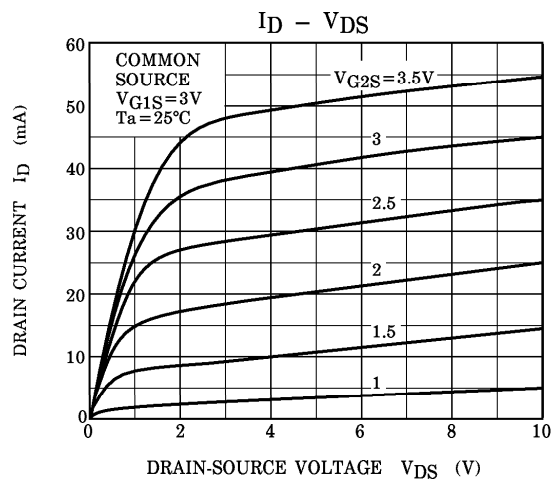
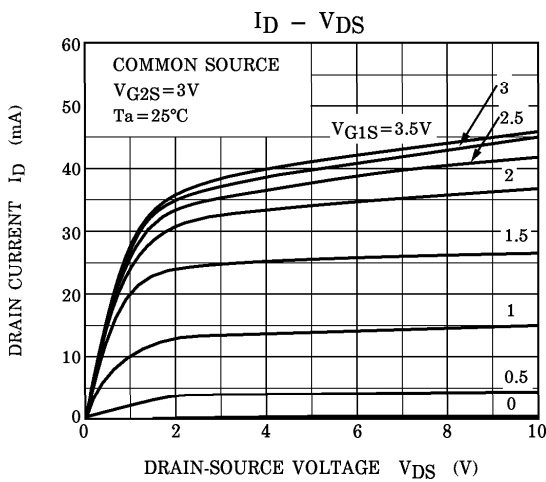

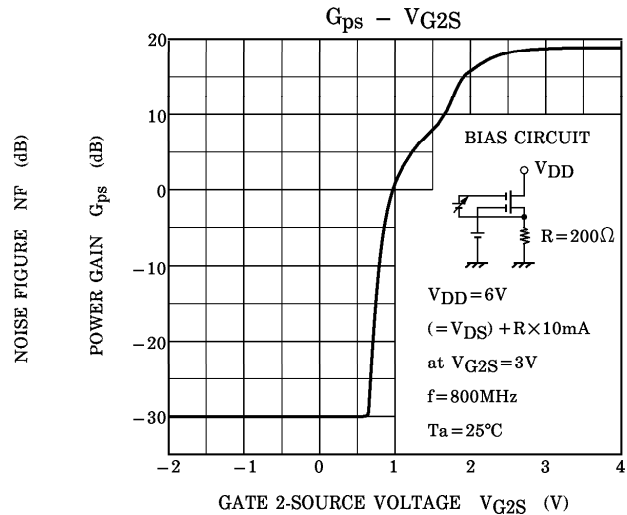
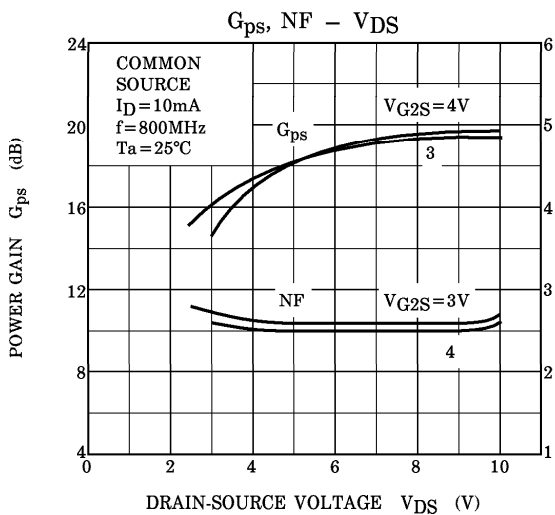
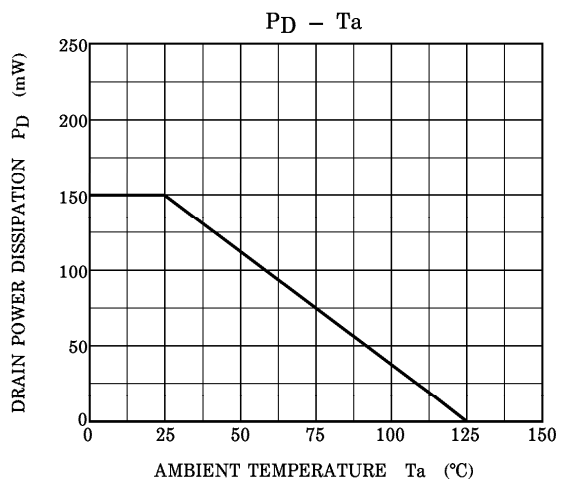
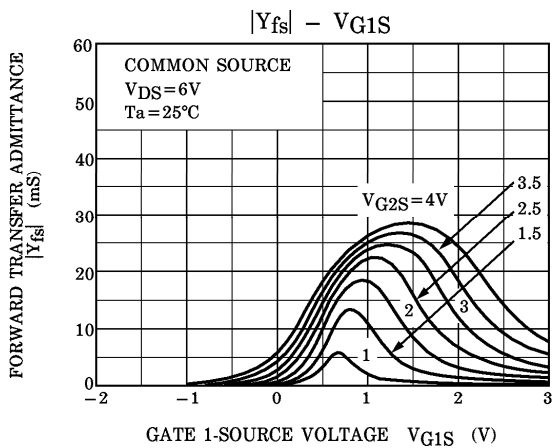
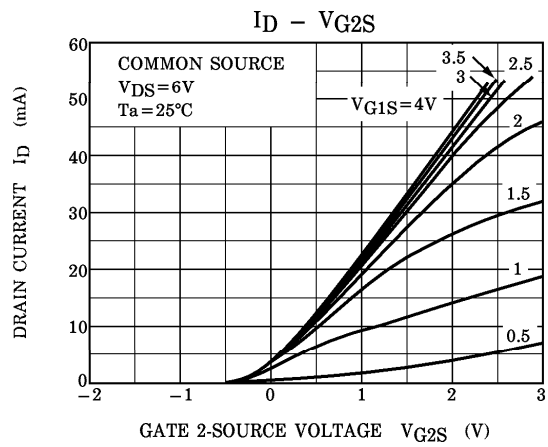
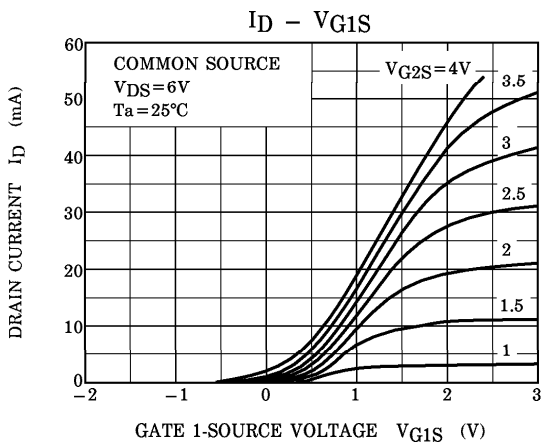

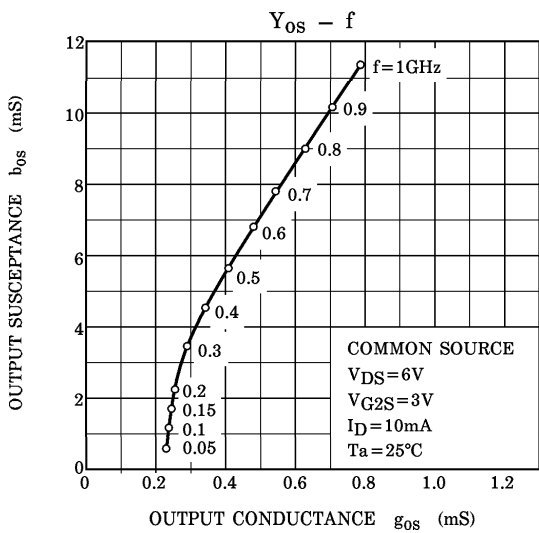
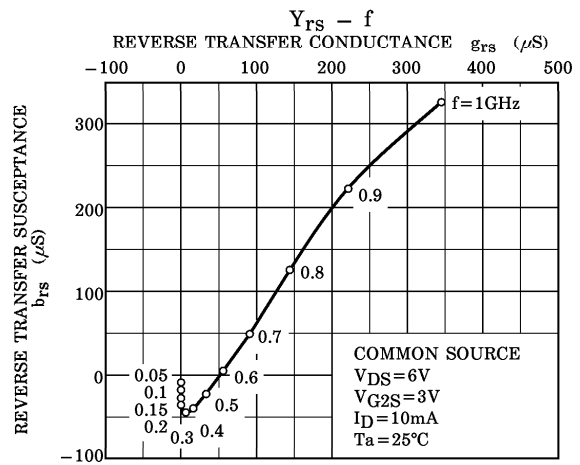
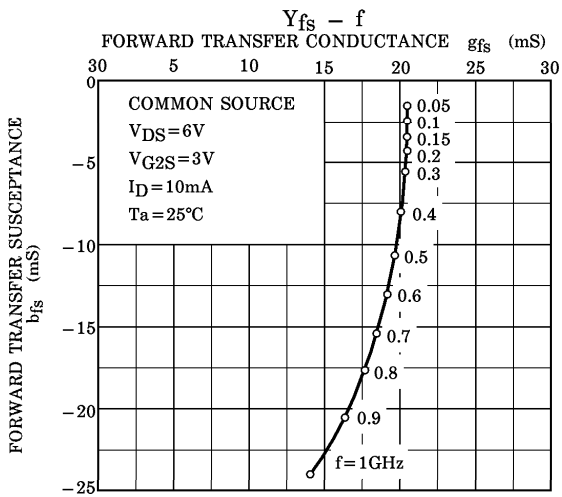
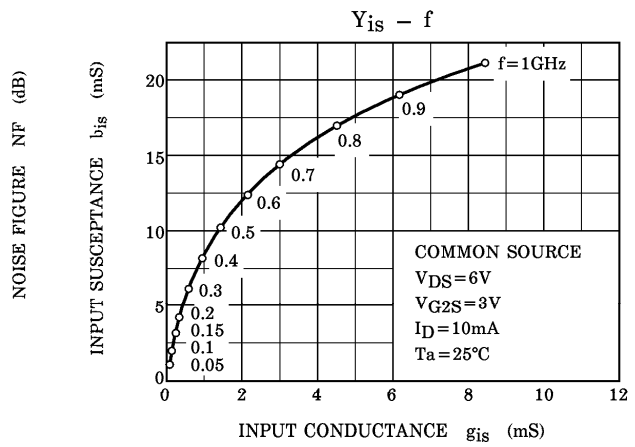
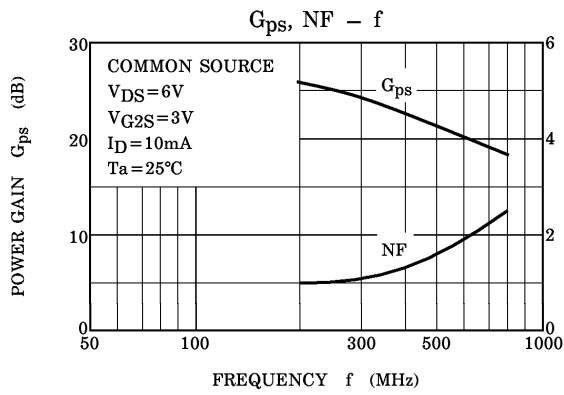

This datasheet has been downloaded from:

[www.DatasheetCatalog.com](http://www.DatasheetCatalog.com)

Datasheets for electronic components.